



DAT Wentylatory

50-451 Wrocław, ul. Komuny Paryskiej 34/4
 tel./fax 071/342 53 89; 071/341 90 14
 tel. 071/78 91 772; 071/78 91 773
 www.dat.wroc.pl
 dat@dat.wroc.pl

WENTYLATORY DACHOWE WVPKH(V)



WVPKH



WVPKV

KONSTRUKCJA:

Wentylatory promieniowe przystosowane do podłączenia kanałów wentylacyjnych lub do pracy bezpośrednio bez podłączeń.

Wylot powietrza: poziomy – wersja H lub pionowy – wersja V

Obudowa stalowa malowana lub wykonana z tworzywa. Stalowy wirnik wyważony statycznie i dynamicznie. Silnik mocowany do płyty nośnej znajduje się poza strumieniem powietrza.

W wykonaniu specjalnym obudowa może być wykonana z blachy kwasoodpornej.

SILNIK ELEKTRYCZNY:

Jednofazowy 230V, 50Hz, lub trójfazowy 400V, 50Hz budowy zamkniętej, o stopniu ochrony IP54.

W wykonaniu specjalnym: silniki wielobiegunowe, silniki o podwyższonym stopniu ochrony lub silniki do pracy w podwyższonej temperaturze

ZASTOSOWANIE:

Stosowane do wentylacji pomieszczeń w budownictwie mieszkaniowym, handlu, gastronomii, usługach, w budownictwie kulturalno-oświatowym, do wentylacji hal sportowych, hal produkcyjnych, magazynowych, itp.

Do wyciągu powietrza lub gazów o gęstości $1,2\text{kg/m}^3$. Temperatura przetłaczanego czynnika: od -15°C do $+45^{\circ}\text{C}$.

WYMIARY:

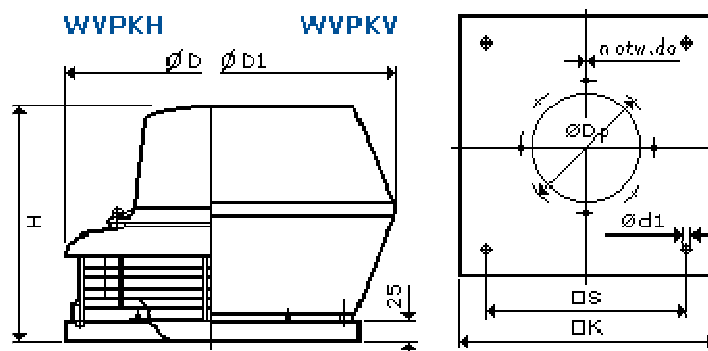

Typ	K [mm]	S [mm]	H [mm]	Ød ₁	n	Ød ₀	ØD _p [mm]	ØD [mm]	ØD ₁ [mm]
WVPKH(V)-160	410	330	403	M8	4	M6	185	454	560
WVPKH(V)-200	455	380	421	M8	4	M6	225	767	630
WVPKH(V)-250	560	450	438	M8	4	M8	280	526	700
WVPKH(V)-315	560	450	465	M8	8	M8	35	586	785
WVPKH(V)-400	670	535	624	M8	8	M8	450	686	925
WVPKH(V)-500	920	750	760	M11	12	M10	560	800	1150*)
WVPKH(V)-630	1020	840	840	M11	12	M10	690	920	1336*)
WVPKH(V)-710	1020	840	1090	M11	16	M10	770	990	1451*)

*) ośmiokąt



DAT Wentylatory

50-451 Wrocław, ul. Komuny Paryskiej 34/4
 tel./fax 071/342 53 89; 071/ 341 90 14
 tel. 071/ 78 91 772; 071/78 91 773
 www.dat.wroc.pl
 dat@dat.wroc.pl

WENTYLATORY DACHOWE WVPKH(V)

DANE TECHNICZNE:

Typ	wydajność max [m³/h]	spręż max [Pa]	obroty [1/min]	moc silnika [kW]	natężenie prądu [A]	zasilanie [V]	głośność [dB(A)] z 4m	masa [kg]
WVPKH(V)-160	1.120	320	1400	0,18	1,45	230	56	14
			1380	0,18	0,65	400		
	720	120	820	0,09	0,45	400	48	14
	560	70	680	0,09	0,55	400	42	15
WVPKH(V)-200	1.810	380	1400	0,37	2,70	230	59	20
			1370	0,37	1,10	400		19
	1.163	140	900	0,18	0,70	400	48	18
	905	89	680	0,09	0,55	400	43	
WVPKH(V)-250	3.700	460	1370	0,55	4,40	230	63	28
	4.040	460	1380	0,55	1,50	400		25
	2.597	181	900	0,25	0,95	400	54	23
	2.020	110	670	0,12	0,60	400	46	
WVPKH(V)-315	5.500	580	1370	0,75	5,65	230	64	34
			1400	0,75	1,90	400		31
	3.300	220	930	0,37	1,25	400	56	27
	2.880	130	690	0,18	0,75	400	51	
WVPKH(V)-400	9.000	800	1400	1,50	9,60	230	73	49
			1420	1,50	3,70	400		47
	6.480	300	920	0,75	2,20	400	65	41
	5.400	180	680	0,37	1,50	400	58	
WVPKH(V)-500	11.570	400	950	3,00	7,70	400	63*)	125
	9.000	190	710	1,10	3,50	400	55*)	117
WVPKH(V)-630	22.320	500	965	5,50	12,60	400	69*)	143
	15.120	240	720	3,00	7,50	400	61*)	140
WVPKH(V)-710	25.200	540	960	7,50	16,80	400	74*)	175
	18.000	260	705	4,00	10,70	400	65*)	165

*) głośność z 10m

CHARAKTERYSTYKI:

WVPKH(V)-160 /1400obr/min

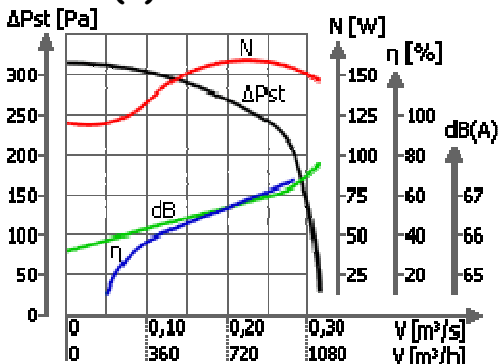

WVPKH(V)-160 /900obr/min

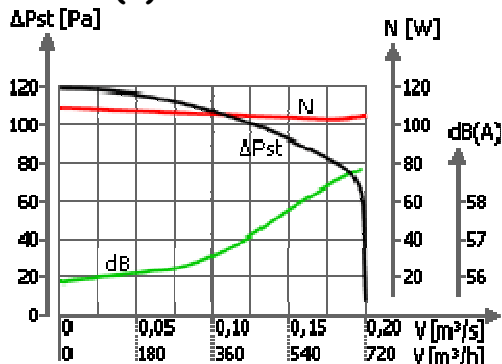



DAT Wentylatory

50-451 Wrocław, ul. Komuny Paryskiej 34/4
 tel./fax 071/342 53 89; 071/341 90 14
 tel. 071/78 91 772; 071/78 91 773
 www.dat.wroc.pl
 dat@dat.wroc.pl

WENTYLATORY DACHOWE WVPKH(V)

WVPKH(V)-160 /700obr/min

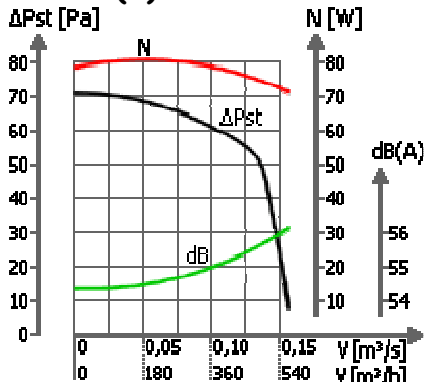

WVPKH(V)-200 /1400obr/min

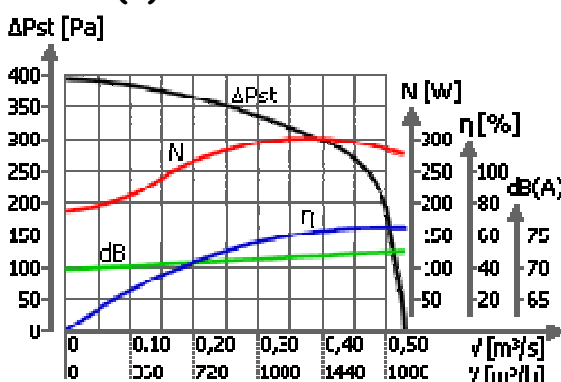

WVPKH(V)-200 /900obr/min

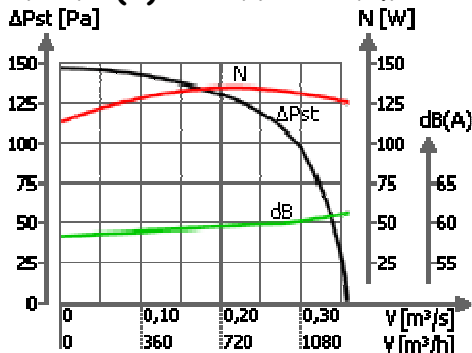

WVPKH(V)-200 /700obr/min

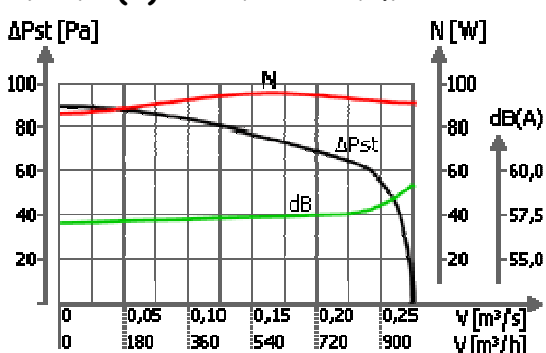

WVPKH(V)-250 /1400obr/min

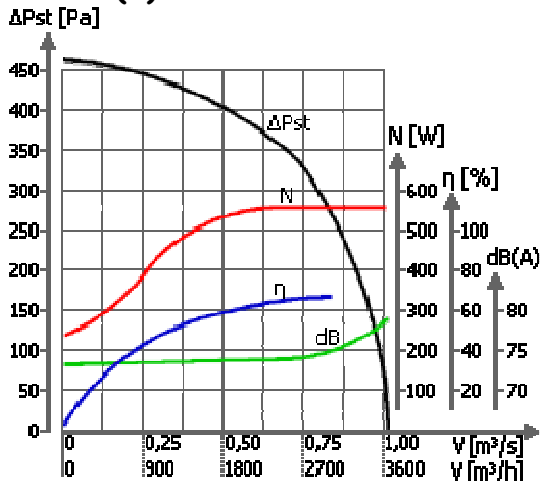

WVPKH(V)-250 /900obr/min

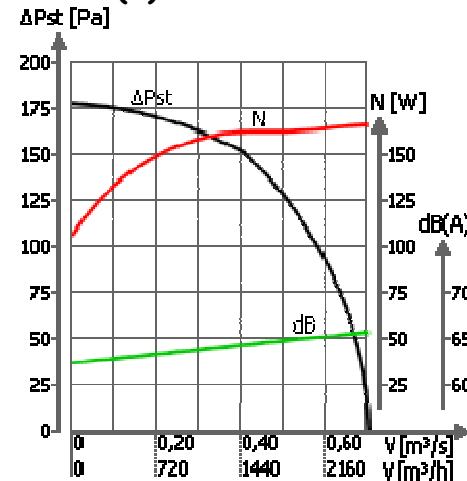

WVPKH(V)-250 /700obr/min

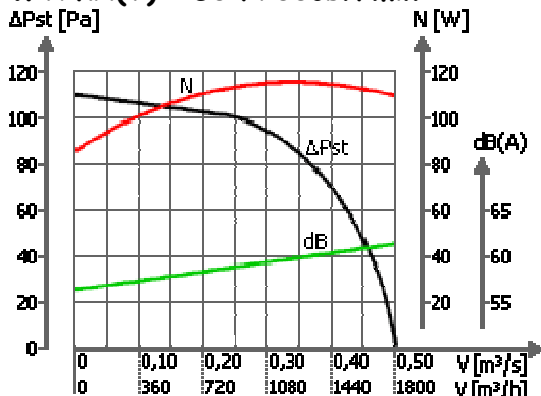

WVPKH(V)-315 /1400obr/min

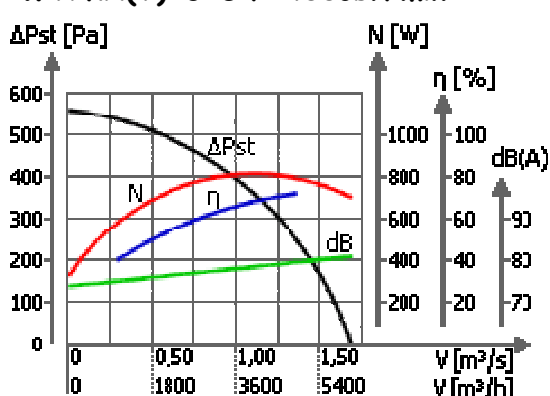



DAT Wentylatory

50-451 Wrocław, ul. Komuny Paryskiej 34/4
 tel./fax 071/342 53 89; 071/ 341 90 14
 tel. 071/ 78 91 772; 071/78 91 773
 www.dat.wroc.pl
 dat@dat.wroc.pl

WENTYLATORY DACHOWE WVPKH(V)

WVPKH(V)-315 /900obr/min

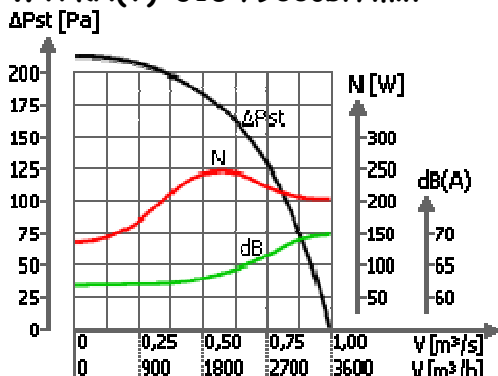

WVPKH(V)-315 /700obr/min

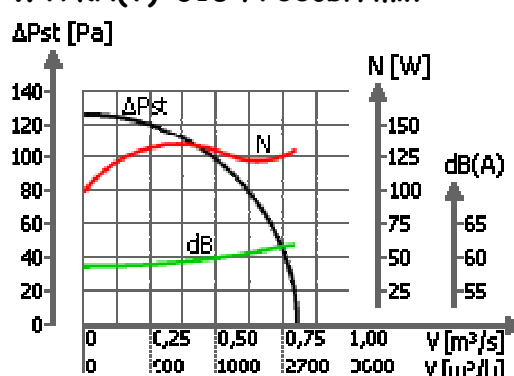

WVPKH(V)-400 /1400obr/min

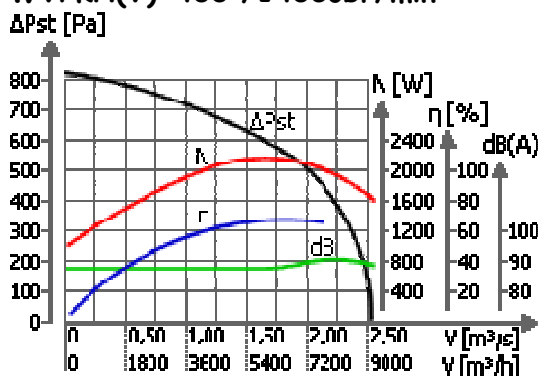

WVPKH(V)-400 /900obr/min

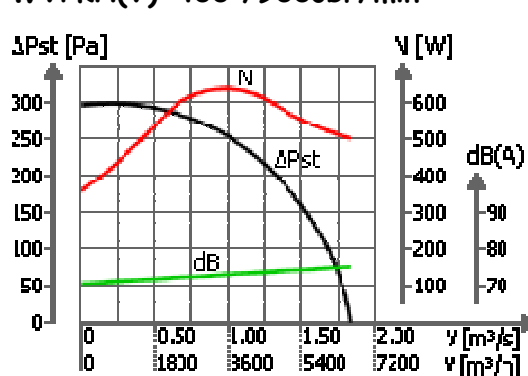

WVPKH(V)-400 /700obr/min

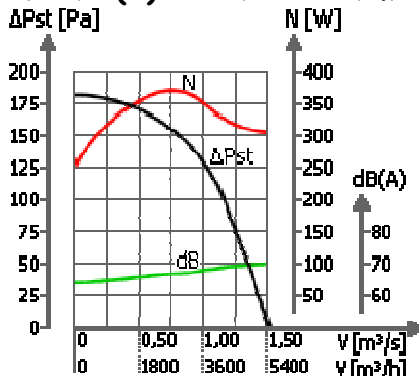

WVPKH(V)-500 /900obr/min

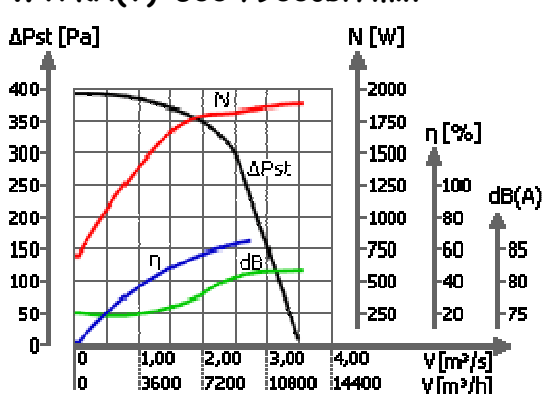

WVPKH(V)-500 /700obr/min

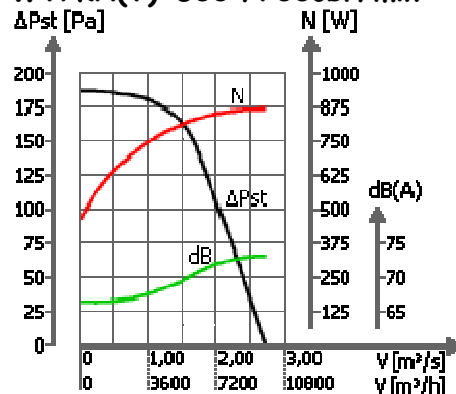



DAT Wentylatory

50-451 Wrocław, ul. Komuny Paryskiej 34/4
 tel./fax 071/342 53 89; 071/ 341 90 14
 tel. 071/ 78 91 772; 071/78 91 773
 www.dat.wroc.pl
 dat@dat.wroc.pl

WENTYLATORY DACHOWE WVPKH(V)

WVPKH(V)-630 /900obr/min

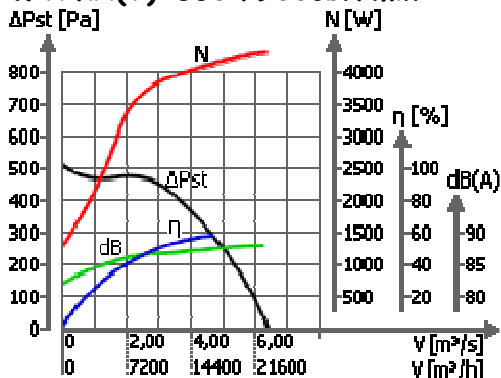

WVPKH(V)-630 /700obr/min

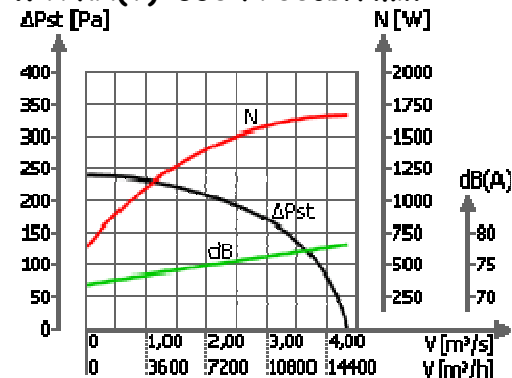

WVPKH(V)-710 /900obr/min

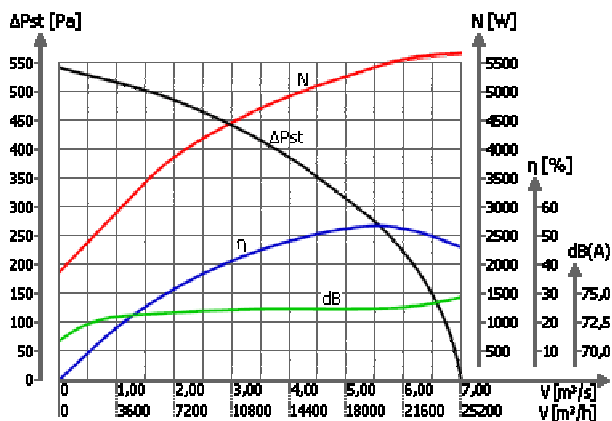

WVPKH(V)-710 /700obr/min

